

PS2R AS-Interface Power Supply

AS-Interface Power Supply with Universal AC Input Voltage

- Input voltage range: 100 to 240V AC
- Two output ratings: 73W and 145W
- Slim housing style mountable on DIN rails
- IP20 finger-safe terminals
- CE marked (LVD, EMCD)
- UL listed (UL 508), CSA (C22.2 No. 950), TÜV (EN60950, EN61010-1)
- Noise standards EN55022, EN61000-6-2 compliant
- Input indicator (orange) and output indicator (green)
- IEC62026-2 compliant



Part Numbers

AS-Interface Power Supply

	Output Capacity	Input Voltage	Output Voltage	Part Numbers
	73W	100 to 240V AC	30.5V DC	PS2R-Q30ABL
	145W			PS2R-F30ABL

PLCs

Operator Interfaces

Automation Software

Power Supplies

Sensors

Communication & Networking

Specifications

Model		PS2R-Q30ABL	PS2R-F30ABL	
PLCs	Efficiency	83% (typical) at the rated input/output		
	Voltage	100 to 240V AC (85 to 264V AC)		
	Frequency	47 to 63 Hz		
	Input Current	100V AC	1.8A (typical) at the rated load	3.0A (typical) at the rated load
		220V AC	1.0A (typical) at the rated load	2.0A (typical) at the rated load
	Leakage Current	3.5mA maximum (UL, CSA, VDE)		
Inrush Current	30A maximum (25°C at cold start)			
Operator Interfaces	Rated Voltage	30.5V DC		
	Rated Current	2.4A	4.8A	
	Adjustable Voltage Range	N/A		
	Ripple Noise Voltage	300mV p-p maximum (0 to 10 kHz), 50mV p-p maximum (10 to 500 kHz) according to AS-Interface standard		
	Input/Load Fluctuation	3%		
	Overall Fluctuation	29.5 to 31.6V DC including input fluctuation, output fluctuation, temperature fluctuation and ripple voltage		
	Delay Time	2 sec maximum (delay in output voltage change from 5V to 26.5V) according to AS-Interface standard		
	Startup Time	1 sec maximum (output voltage change from 21.5V to 29.5V) according to AS-Interface standard		
	Output Holding Time	10ms minimum at 85V AC, rated load		
	Automation Software	Overcurrent Protection	110% (typical), automatic reset ¹	
Overvoltage Protection		120% minimum ²		
Undervoltage Protection		95% maximum, automatic reset		
Input Indicator		Orange		
Output Indicator		Green		
Dielectric Strength		Between inputs and outputs: Between inputs and ground: Between outputs and ground:	3.0 kV AC, 1 minute 3.0 kV AC, 1 minute 0.5 kV AC, 1 minute	
Insulation Resistance		Between inputs and outputs: Between inputs and ground:	100 MΩ minimum (500V DC megger) 100 MΩ minimum (500V DC megger)	
Operating Temperature		0 to 60°C (See the derating curve.) Vertical mounting only		
Storage Temperature		-25 to +70°C (no freezing, non-condensation)		
Operating Humidity		95% RH (non-condensation)		
Vibration Resistance		10 to 57 Hz amplitude 0.075mm, 57 to 150 Hz acceleration 10 m/s ² (1G) 10 cycles per axis on each of three mutually perpendicular axes		
Shock Resistance		147 m/s ² (15G), 11ms duration, 2 shocks per axis, on six mutually perpendicular axes		
Terminal		IP20		
Weight (approx.)		800g	1300g	
Dimensions		120H x 54W x 120D mm	120H x 81W x 120D mm	
Safety Standards		UL 508 listed CSA C22.2 No. 950 EN60950, EN61010		
AS-Interface Standard		EN50295		
EMC	(EMI) Radiated Emission	IEC61000-6-2 EN55022 class B		
	Conducted Emission	EN55022 class B		



1. The AS-Interface power supply is provided with an overvoltage protection circuit, but a long period of overload and short-circuit should be avoided.
2. After turning off the input voltage, allow more than 10 seconds before turning on again.

Block Diagram

PS2R-Q30ABL
PS2R-F30ABL

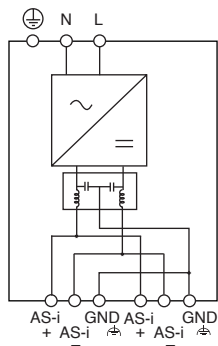

Output Derating

(Operating temperature is the temperature around the power supply)

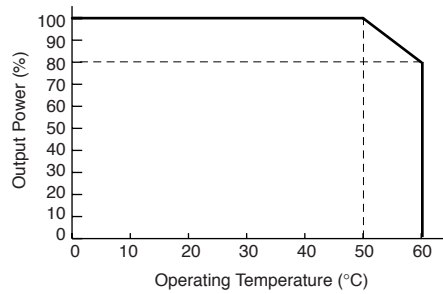

Terminal Names

- ① (L) AC input terminal
- ② (N) AC input terminal (ground side)
- ③ (⊕) Ground terminal (protective ground)
- ④ (AS-+) AS-Interface + output terminal
- ⑤ (AS-) AS-Interface - output terminal
- ⑥ (⊖) Ground terminal (output side)
- ⑦ (-) Input indicator (goes on when AC input is on)
- ⑧ (AS-i) Output indicator (goes on when DC output is on)

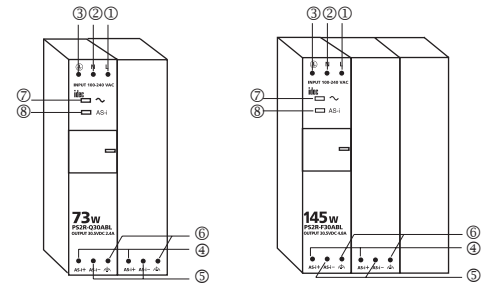

Dimensions

PS2R-Q30ABL

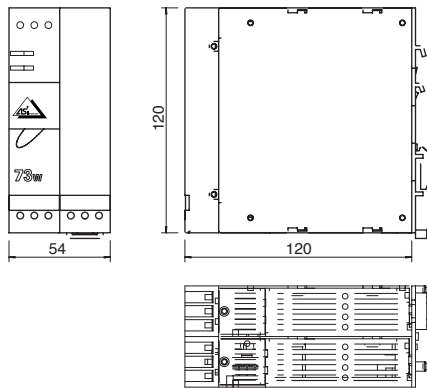

PS2R-F30ABL

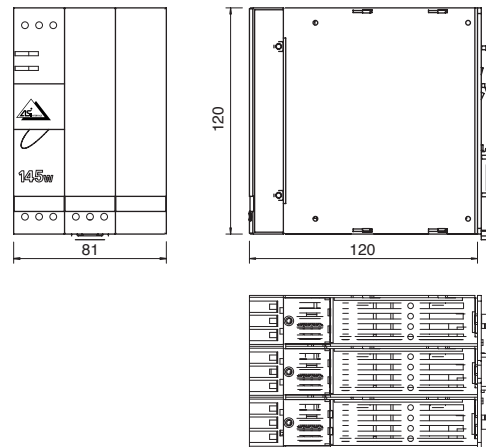

All dimensions in mm.

Precautions for Installation

1. Heat Dissipation by Convection

Keep minimum spacing of 50mm above and below, and 15mm on both sides to ensure proper ventilation.

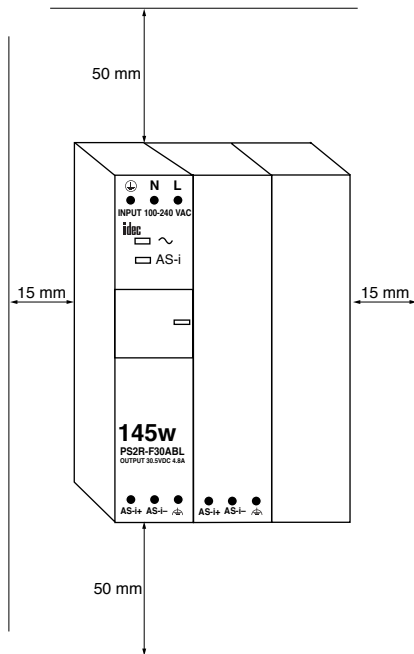

2. Applicable Wires, Ferrules and Tightening Torque

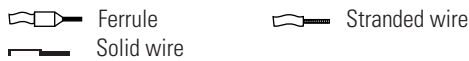

Ferrule/Wire					
mm ²	0.14 to 1.5	0.14 to 0.75	0.14 to 2.5	0.14 to 4	0.14 to 1.5
AWG	26 to 16	26 to 18	26 to 14	26 to 12	26 to 16

			0.6 N•m
ø3.5mm			5.4 in•lbs

3. Mounting on 35mm-wide DIN Rails

Mounting

To mount the power supply on a DIN rail, place the input terminal side up and put the groove of the power supply on the DIN rail as shown. Press the power supply towards the DIN rail.

Removing

Insert a flat screwdriver into the slot in the clamp. While pulling out the clamp, turn the power supply bottom out.

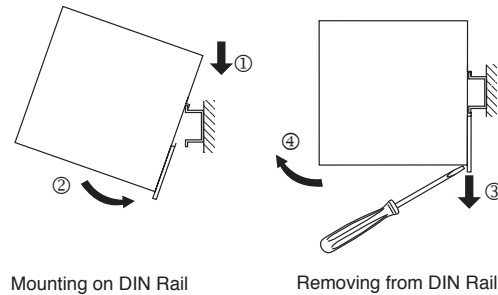

Mounting Direction

The AS-Interface power supply can be mounted on a vertical plane only. Other mounting directions are not allowed because of heat dissipation.

Over Current Protection

When an overcurrent of 110% of the rated output current flows due to an overload, the output voltage drops automatically and intermittent operation starts.

When the load returns to normal conditions, the normal output voltage is automatically restored. Prevent overload or short-circuitry for a long period of time, otherwise the internal elements will be damaged.

Overvoltage Protection

When the output voltage exceeds 120% the rated output voltage, the output is turned off. When the output voltage is turned off due to an overvoltage, turn the input off, and after more than 10 seconds, turn the input on again.

Undervoltage Protection

When the output voltage drops below 95% the rated output voltage, the output is turned off. When the cause of the error is removed, normal output voltage is automatically restored.